

Cod. 3010.2054 3010.2040	Tipo - Type VA03 - AP70/LL - 37A Aspirante - <i>Suction</i> VA03 - AP70/LL - 37S Soffiante - <i>Blowing</i>	Diametro ventola - <i>Fan diameter</i> 280 mm
--	---	---

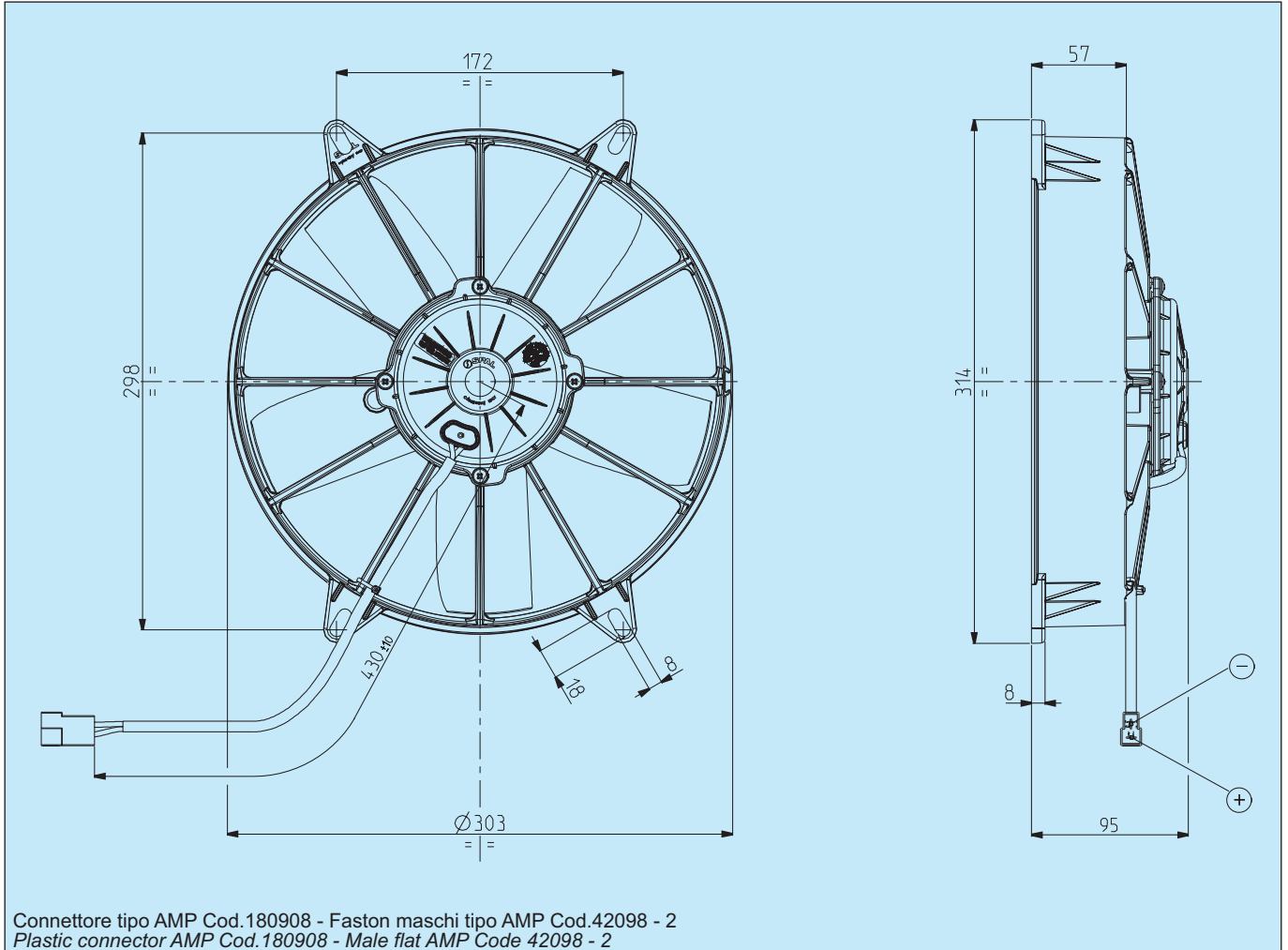

* Peso 2,370 kg. circa

* *Weight 2,370 Kg. approx.*

* Motore chiuso, IP 68

* *Waterproof motor, IP 68*

* Lunga durata

* *Long life*

* A richiesta (per applicazioni OEM) disponibile anche in versione VLL.

* *Available also in VLL version for OEM applications only.*



Tensione di prova 13 V cc - *Test voltage 13 V DC*

Pressione statica <i>Static pressure</i> mm H ₂ O	Portata <i>Airflow</i> m ³ /h	Corrente assorbita <i>Current input</i> A
0	2310	14,0
5	2070	15,4
10	1820	16,0
15	1420	16,6
20	970	17,2
25	700	18,1
30	530	18,6
35	340	19,4
40	100	20,5
45	0	20,9

Static pressure: 1 mm H₂O = 0,04 in. H₂O
Airflow: 1 m³/h = 0,59 cfm