

12V C.C. - D.C.

VA03-AP70/LL-37A  
VA03-AP70/LL-37S

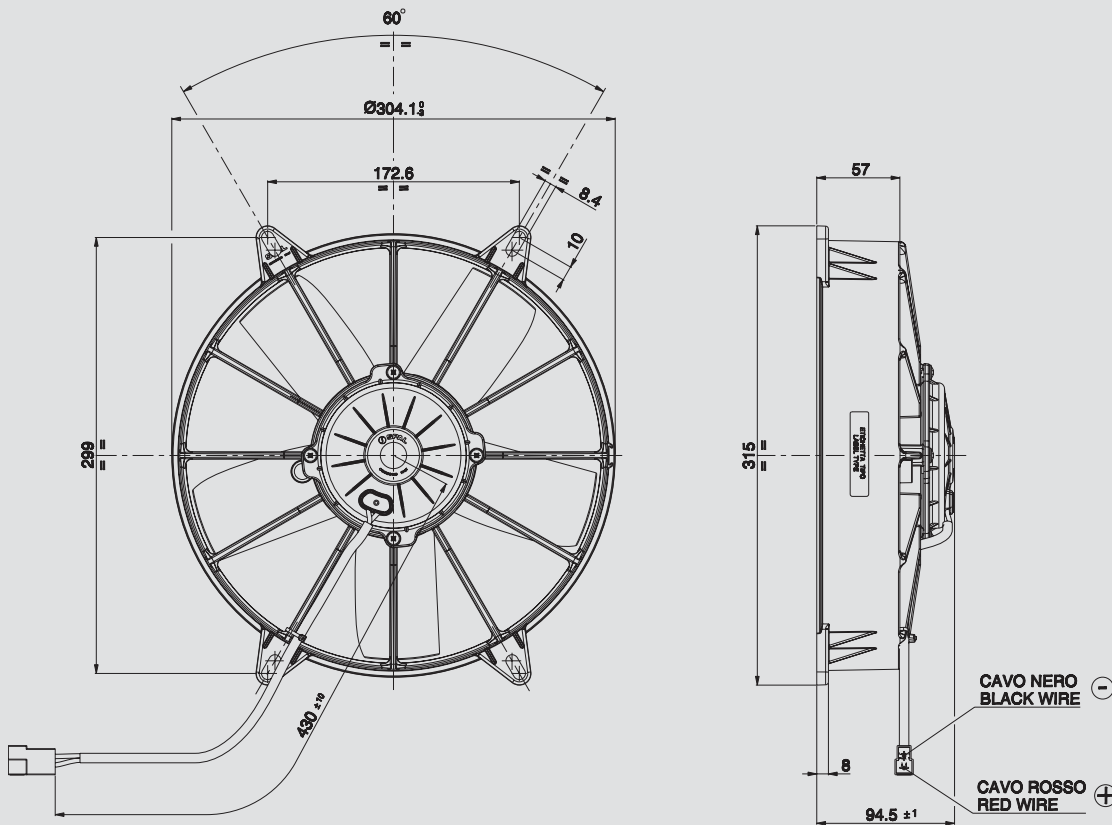

AMP connector Code 180908  
AMP terminal Code 42098-2  
Suggested mounting torque: 3(+1/-0) Nm with screw M8  
Weight 2,37 Kg. approx.

Connettore AMP Cod. 180908  
Terminali AMP Cod. 42098-2  
Coppia di serraggio consigliata: 3(+1/-0) Nm con vite M8  
Peso 2,37 Kg. circa

Ø 280 mm  
Ø 11"

suction / aspirante

blowing / soffiante

PRODUCT FEATURES  
CARATTERISTICHE PRODOTTO

Static pressure Pressione statica mm H <sub>2</sub> O	suction / aspirante			blowing / soffiante			Static pressure Pressione statica in H <sub>2</sub> O
	Airflow Portata m <sup>3</sup> /h	Current input Corrente assorbita A	Airflow Portata CFM	Airflow Portata m <sup>3</sup> /h	Current input Corrente assorbita A	Airflow Portata CFM	
0	2330	12,8	1375	2220	11,2	1310	0
5	2100	14,0	1239	1970	12,2	1162	0,2
10	1770	14,4	1044	1720	13,0	1015	0,4
15	1230	13,9	726	1380	13,5	814	0,6
20	860	15,0	507	1010	14,2	596	0,8
25	630	15,6	372	670	14,5	395	1
30	440	16,0	260	410	15,0	242	1,2
35	170	17,1	100	140	16,1	83	1,4
40	0	18,4	0	0	17,1	0	1,6

Waterproof motor, IP 68 Motore chiuso, IP 68	✓
Long life / Lunga durata	✓
VLL version* / Versione VLL*	✓
Waterproof connector Connettori a tenuta stagna	✓

\* for OEM applications only.  
\* per applicazioni OEM

✓ = Standard feature  
Caratteristiche standard  
✓ = Available upon request  
Disponibile su richiesta

Test voltage 13 V. d.c. - Tensione di prova 13 V. c.c.