

12V C.C. - D.C.

VA59-AP70/LL-37A
VA59-AP70/LL-37S

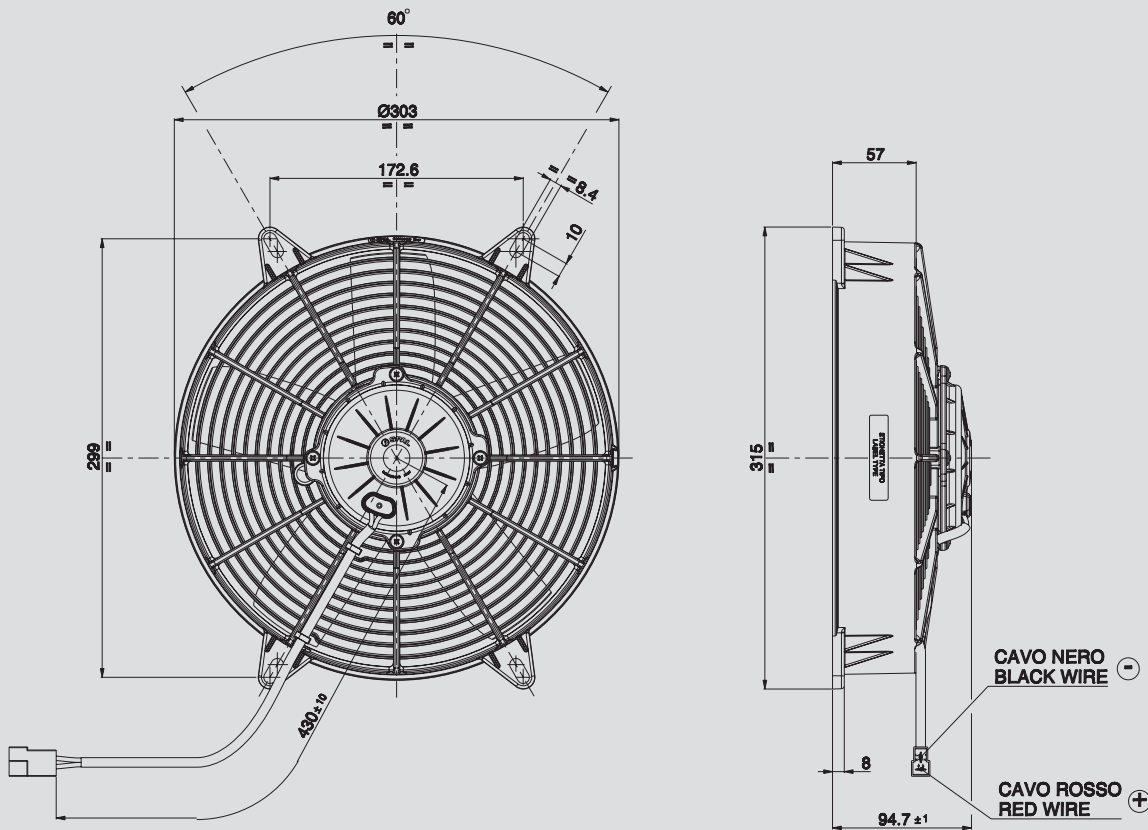

AMP connector Code 180908
AMP terminal Code 42098-2
Suggested mounting torque: 3(+1/-0) Nm with screw M8
Weight 2,41 Kg. approx.

Connettore AMP Cod. 180908
Terminali AMP Cod. 42098-2
Coppia di serraggio consigliata: 3(+1/-0) Nm con vite M8
Peso 2,41 Kg. circa

Ø 280 mm
Ø 11"

suction / aspirante

blowing / soffiante

PRODUCT FEATURES
CARATTERISTICHE PRODOTTO

Static pressure Pressione statica mm H ₂ O	suction / aspirante			blowing / soffiante			Static pressure Pressione statica in H ₂ O
	Airflow Portata m ³ /h	Current input Corrente assorbita A	Airflow Portata CFM	Airflow Portata m ³ /h	Current input Corrente assorbita A	Airflow Portata CFM	
0	2070	13,8	1221	2040	13,1	1204	0
5	1840	13,8	1086	1790	13,4	1056	0,2
10	1510	14,0	891	1510	13,7	891	0,4
15	1150	13,7	679	1140	14,0	673	0,6
20	860	14,2	507	840	14,4	496	0,8
25	630	14,8	372	610	14,8	360	1
30	460	16,0	271	400	15,5	236	1,2
35	220	16,4	130	150	17,5	89	1,4
40	0	18,5	0	0	18,8	0	1,6

Waterproof motor, IP 68 Motore chiuso, IP 68	✓
Long life / Lunga durata	✓
VLL version* / Versione VLL*	✓
Waterproof connector Connettori a tenuta stagna	✓

* for OEM applications only.
* per applicazioni OEM

✓ = Standard feature
Caratteristiche standard
✓ = Available upon request
Disponibile su richiesta

Test voltage 13 V. d.c. - Tensione di prova 13 V. c.c.